

## CHARACTERISTICS

	STANDARD	AVAILABLE OPTIONS
<b>Technology</b>	Eccentric Disc Mouvex®	
<b>Maximum Flow rate at 1 cSt m<sup>3</sup>/h (GPM)</b>	18 (79)	
<b>Cubic capacity L (cu.in)</b>	0.7124 (43.47)	
<b>Internal relief valve</b>	With	Double, Without
<b>Rotation</b>	Reversible	
<b>Ports</b>	Flanges	
<b>Heating</b>	None	Heating jacket
<b>Dimensions mm (in.)</b>	<b>A</b> 400 (15.75)	
	<b>B</b> 370 (14.57)	
	<b>C</b> 165 (6.50)	
	<b>D</b> 366 (14.41)	
	<b>E</b> 165 (6.50)	
<b>Weight kg (lbs)</b>	66 (146)	

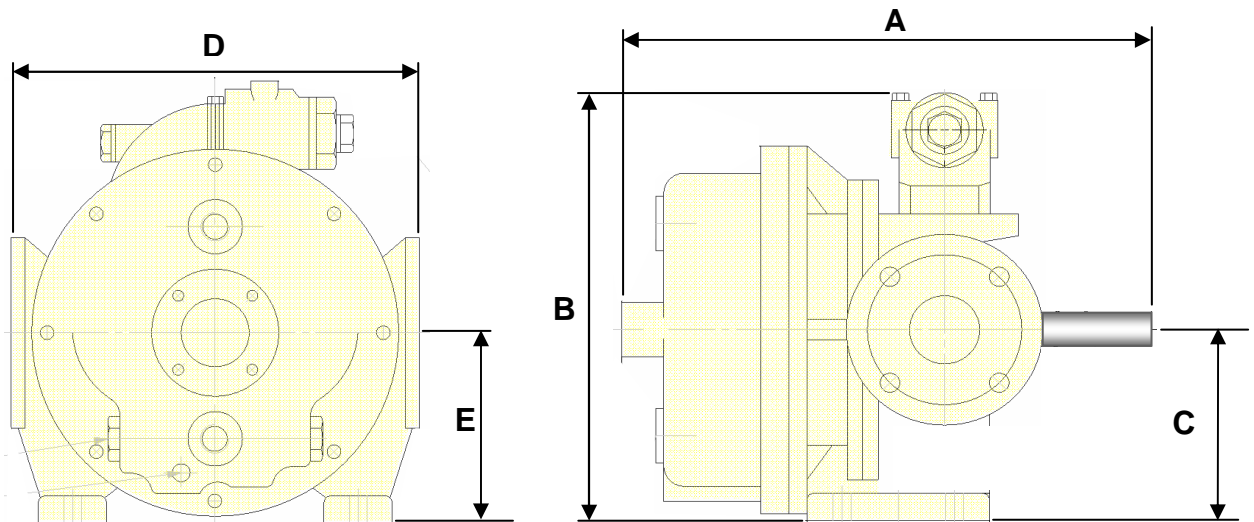

### OPERATING LIMITS

	STANDARD MATERIALS
Minimum temperature °C (°F)	-10 (14)
Maximum temperature °C (°F)	150 (302)
Maximum viscosity cSt (SSU)	15000 (69500)
Maximum differential pressure bar (psi)	5 (72)
Maximum speed (rpm)	450

### MATERIALS OF CONSTRUCTION

Part No	PART NAME	STANDARD MATERIALS	AVAILABLE OPTIONS
101	Main Body	Cast iron	
201	Cylinder	Cast iron	
301	Disc	Ductile iron	
401	Front cover	Cast iron	
501	Shaft	Carbon steel	
	Bushings	Carbon	Bronze
	Static O-rings	FKM	EPDM
	Mechanical seal	Carbon/stainless steel/FKM	Carbon/stainless steel/FEP Bronze/stainless steel/FKM Bronze/stainless steel/FEP Tungsten carbide/Tung. C / FKM Tungsten carbide/Tung. C / FEP

